

714-8 eight zone expander
Address #00 Zones 500-507
for Riser Flow & Tamper
Monitoring

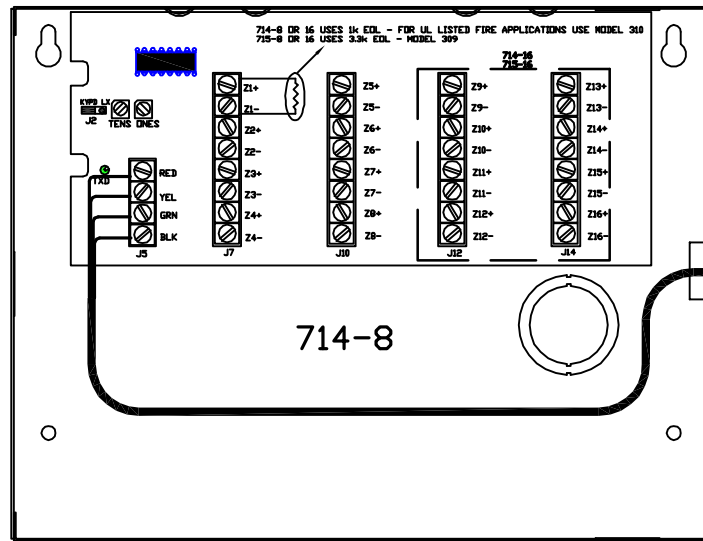

LX Bus wire 4 conductor
18 awg non shielded.
Zones 500-507

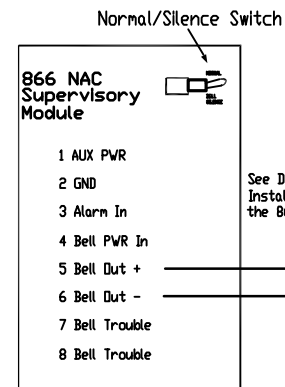

10K EOLR
DMP Model 308

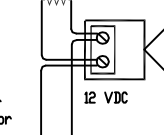

3.3K Ohm EOL

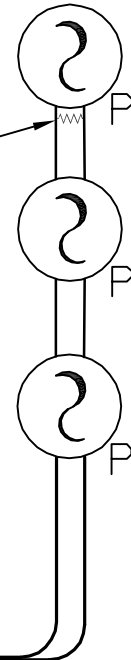

Network
Connection to
LAN/WAN

893A Dual Phone
Line Module

Phone Line
Connection 358

LX Bus #1
Connection

690F-R Keypad Address #1

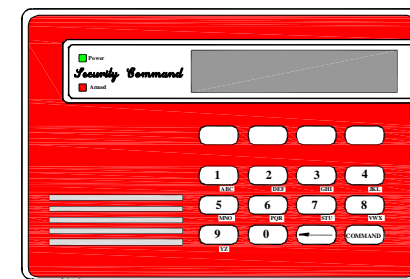

3.3K Ohm EOL

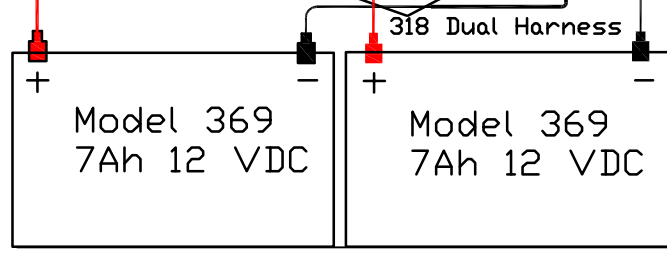
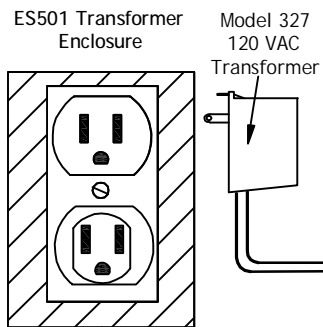

369 12 vdc, 7 ah
Batteries

Architects and Engineers CAD Drawings		 Digital Monitoring Products 2841 E. Industrial, Springfield, MO 65802	
FILE NAME	TITLE	Typical Fire Application	
DRAWN LK	DATE 9-19-07	PART NO.	REV.
CHECKED	SCALE NTS		
APPR'VD	SHEET 1 OF 1		